

# Spiral Integration and Maintenance at a Glance RYSON

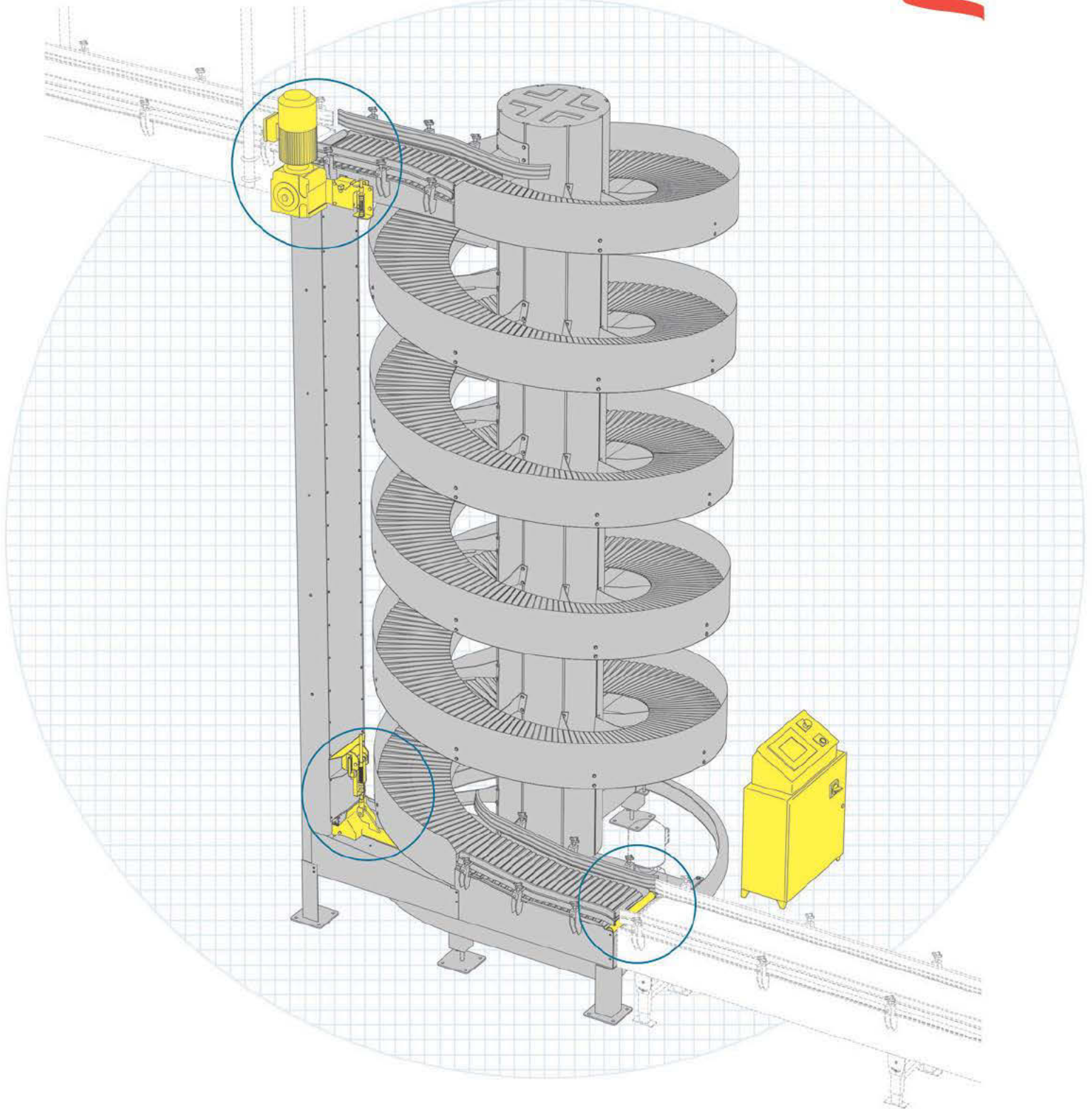

Ryson International manufactures high quality Spiral Conveyors, designed for low maintenance and long life. All Ryson Spiral Conveyors are shop tested prior to shipment, but depend on proper integration with the overall conveyor system for optimal performance. Failure to follow these instructions will adversely affect spiral performance, longevity and may also void the warranty. For more detailed information consult the matching section in the manual provided with your spiral.



## 1. Conveyor Controls (section 4.1.1)

- The controls must be designed to prevent unintended accumulation and prevent product back-ups in the spiral.
- The controls should be set up in a cascading control method.
- The infeed conveyor must not start until the spiral is running at full speed.
- The spiral must stop anytime the outfeed conveyor is full or stopped.
- We recommend the use of a photoeye to detect when the out feed conveyor is full, preventing loads from backing up into the spiral.
- We recommend a local, slow speed jog station, to facilitate easy maintenance.



## 2. Conveyor Speeds (section 4.1.2)

- The speeds of the infeed, spiral and outfeed conveyors must be matched. Max. speed 200 fpm.
- A speed differential between these conveyors will lead to premature wear of the friction inserts and the chain assembly.



## 3. A VFD Is Required (section 4.1.3)

- A VFD (variable frequency drive) is required for the proper operation of the spiral.
- The spiral controls must utilize an acceleration of a minimum 3-5 seconds. Longer ramp-up may be needed for taller spirals and heavy loads.
- The spiral controls must utilize a deceleration of a minimum 3 seconds.

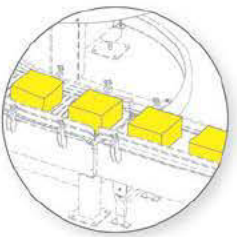

## 4. Gap Between Loads (section 4.1.4)

- There must be a gap between the loads when they enter the spiral.
- The minimum gap should be  $\frac{1}{4}$  of the product length, but a larger gap may be required for spirals with heavy loads to prevent spiral overloading.
- The spiral cannot be used to pull a gap between loads.

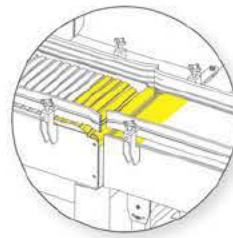

## 5. Conveyor Transitions (section 4.1.5)

- The loads must be powered in and out of the spiral.
- The use of gravity conveyors is not recommended as they do not assure a proper gap between loads.
- Loads must be positioned within the slat width prior to entering to the spiral.
- Product must be properly turned prior to entering to the spiral.
- The infeed conveyor should be  $\frac{1}{8}$ " to  $\frac{1}{4}$ " higher than the spiral.
- The outfeed conveyor should be  $\frac{1}{8}$ " to  $\frac{1}{4}$ " lower than the spiral.
- The transition rollers on the Ryson Spiral are independently adjustable at the infeed and outfeed.

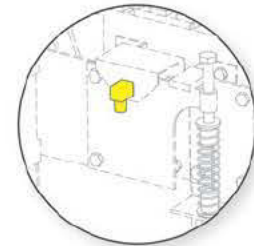

## 6. Proximity Sensors (section 4.2.5)

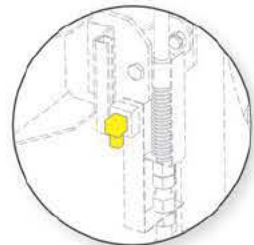

- Two proximity sensors are utilized on the Ryson Spiral to monitor faults associated with a slack chain or a motor over-torque condition.
- These proximity sensors must be wired as inputs to the control PLC and programmed as fail-safe devices.
- Loss of a signal is a fault and the PLC program should immediately (without time delays) shut down the spiral.
- These faults also need to be programmed as latching manual reset faults which require an operator to reset the controls before the spiral can be re-started.
- Sensors must be hooked up according to the supplied vendor schematics as they can be damaged if hooked up improperly.
- The following Turck sensor schematics (shown below) is the Ryson standard.

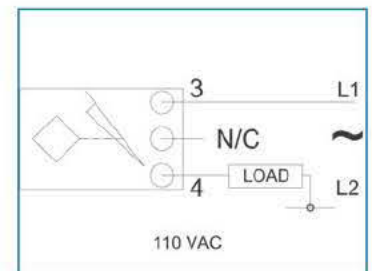
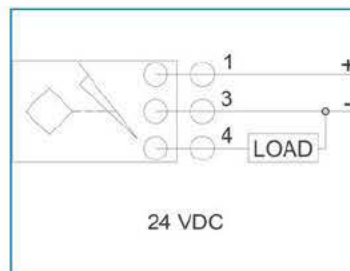



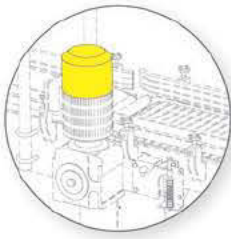

## 7. Motor Brakes (section 4.4)

- Most spiral applications do not require a brake. For taller spirals with heavy loads, a brake is used to prevent rollbacks and drifting when the spiral is stopped.
- The brake must be powered with a dedicated power source separate from the motor.
- The motor is powered by the VFD and the motor voltage is ramped-up at start-up, but is not sufficient to fully release the brake.
- The brake must be released (powered) before the motor is started and set (de-energized) after the motor has come to a complete stop.
- Brake coils from SEW Eurodrive are available in different voltages. Please consult the manual supplied with your spiral for the proper brake voltage.

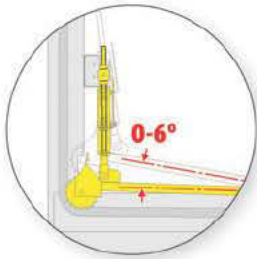

## 8. Chain Tensioner Adjustments (section 6.2)

- An automatic chain tensioning device has been provided to assure that the chain stays in tension at all times.
- Operation of the spiral with insufficient chain tension can cause the spiral to malfunction or have premature wear.
- The tensioner bar position must operate at an angle between 0° (horizontal) and 6°.
- The compressed spring should measure 140 mm.
- The tensioner flag should operate between the green and red markers.
- The slack chain proximity sensor should be adjusted so that the spiral shuts down if the tensioning bar falls below 0° (approximately 2" from the top of the flag to the bottom of the proximity sensor face).

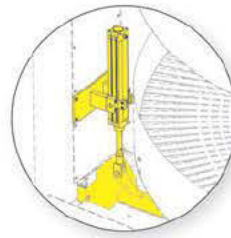

## 9. Air Cylinder Chain Tensioners (section 4.5)

- Air cylinders are used instead of the standard spring tensioning device on very tall spirals and with heavy loads or spirals supplied with the reversible option.
- All air cylinders will have a low air pressure switch, which is used to monitor the supply air and should be hooked up as a N.O. (normally open) device and programmed as fail-safe to shut down the spiral with a latching, manual reset fault.
- Non-reversible spirals will have one regulator which should be set to 15 PSI for an up spiral, or 20 PSI for a down spiral. Larger units may need higher pressure to achieve proper tension - consult your owners manual.
- Reversible Spirals will have a 4-way solenoid valve (24V DC or 110V AC), a shuttle valve and two regulators. The forward (up) direction regulator is to be plumbed to the N.O. (normally open) porting of the 4-way solenoid valve and the forward regulator set to 15 PSI. The reverse (down) regulator is to be plumbed to the N.C. (normally closed) port of the 4-way solenoid valve and the reverse regulator set to 20 PSI.
- The reverse direction of the spiral should be at slow speed, not to exceed 60 FPM.

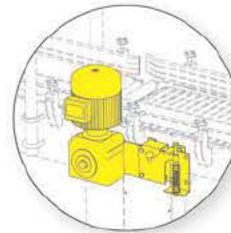

## 10. Motor Overload Adjustments (section 6.5)

- An overload protection device with a proximity sensor has been provided to stop the spiral in case of overloading or jamming of the spiral chain.
- The drive motor is mounted on a torque arm bracket with a spring assembly. The spring applies a torque resistance which can be adjusted to the desired torque limit.
- The torque assembly will pivot when torque exceeds a pre-set limit set by the amount of spring compression.
- The torque resistance should be set for maximum protection without impeding regular operation.
- The proximity sensor can also be adjusted vertically and horizontally for more or less torque sensitivity.





# Recommended Preventative Maintenance Program

The Ryson Spirals require little maintenance. The bearings are lubricated for life and the chain requires infrequent lubrication. The chain will stretch during operation and needs to be shortened occasionally.

## Daily:

1. Inspect chain and replace any damaged or missing parts. Do not run the spiral with missing parts.

## Weekly:

1. Check the chain tension. Shorten the chain when needed. The chain may have to be shortened within the first 200 hours of operation (see the chain shortening instructions in the manual).
  - The chain tension bar should operate at an angle between 0° and 6°. The chain needs to be shortened when the tension bar is at or below 0° (horizontal).
  - **Spirals with spring tensioner** - Check the spring compression. The compressed spring should measure 140mm. The tensioner flag should operate between the red and the green markers.
  - **Spirals with air operated tensioner** - Check the tensioner air pressure. For the forward direction (up) the pressure should be set at 15 PSI, and the reverse direction (down) at 20 PSI. Larger units may need higher pressure to achieve proper tension - consult your owners manual.
2. Check the transition rollers and holders. All rollers should turn freely and be adjusted to the correct height for smooth transitions. All hardware should be tight.
3. Check speed matching. The in-feed, spiral and out-feed conveyors must be running at the same speed.
4. Check the guide rails for proper position. All hardware should be tight.

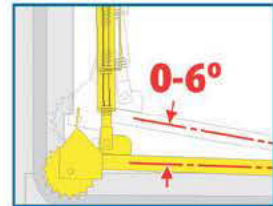

## Monthly:

1. Check the chain tensioner and safety circuit for functionality. Fault out the slack chain proximity sensor. The spiral and the infeed conveyors should stop immediately and **not** automatically restart.
2. Check the overload protection device and safety circuit for functionality. Fault out the overload proximity sensor. The spiral and the in-feed conveyors should stop immediately and **not** automatically restart.
3. Check the outfeed jam sensor for functionality. Loads should not back up into a running spiral. The spiral and the infeed conveyors should stop immediately.



## Quarterly:

1. Check the chain and sprockets for wear and lubrication. Apply lubricant only when required, and apply sparingly to prevent dripping and buildup. Do not lubricate plastic parts. We recommend the use of a spray application (see photo) or a brush on method.

## Every 2 years:

1. Change oil in the motor gearbox.

Please refer to the maintenance manual for more details. The Ryson Service Department is always available to assist with installation and service questions. Feel free to call 757.898.1530 or e-mail [service@ryson.com](mailto:service@ryson.com) with questions.